

POWERGEAR®

王牌路軌

版本號：4.00

參數表 | 四線三迴路嵌入式導軌-2米 (2000mm)

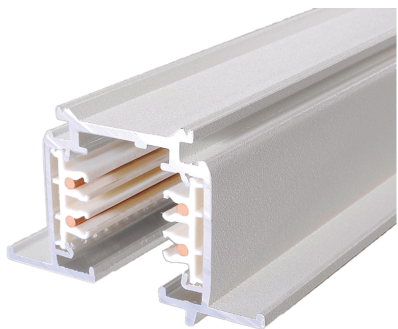

圖片僅供參考，應以實物為準

產品型號	PRO-R420
顏色	黑 / 灰 / 白
色號	RAL 9005 / 7040 / 9016
材質	無氧銅+鋁
最小包裝	N/A
每條淨重	1.92 kg
每箱包裝	9 PCS
每箱毛重	18.16 kg
外箱尺寸	2015*155*110 mm
參數	250V~/440V 3N~ 16A, 120V~ 20A

產品尺寸 (mm)

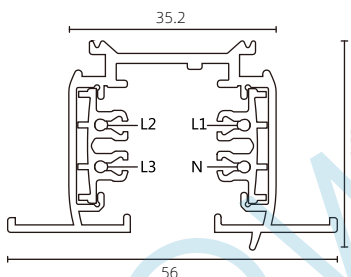

接線方式

四線三迴路導軌系統

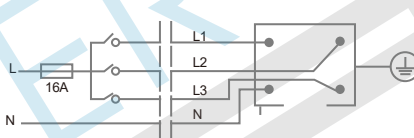

單相電 250V~ 16A Max.

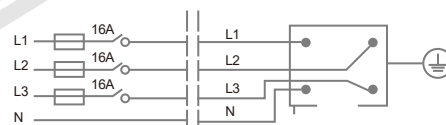

三相電 440V 3N~ 16A Max.

軌道承重&開孔

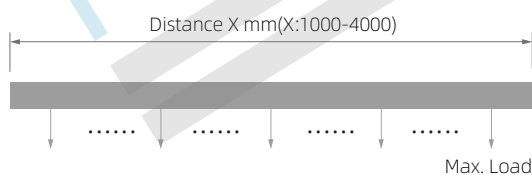

備註：
每個安裝點最大100N
每米最大有5個安裝點

L / mm	a / mm	b / mm	c / mm	d / mm	F Max./N
1000-1499	125				300N
1500-2499	125	995			450N
2500-3499	125		914	1172	600N
3500-4000	125		1247	1506	600N

L= Track length

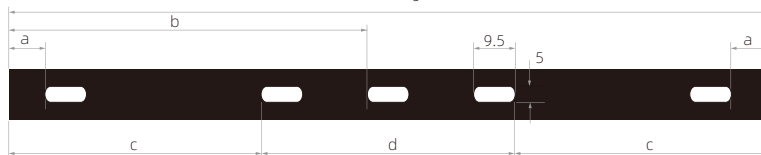

安裝示意 請在產品安裝前仔細閱讀本說明

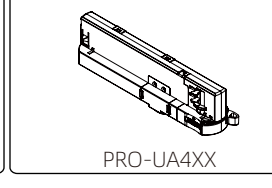
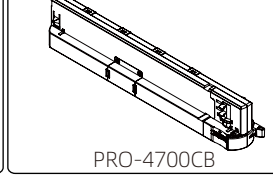
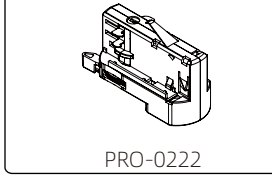
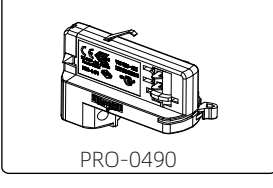
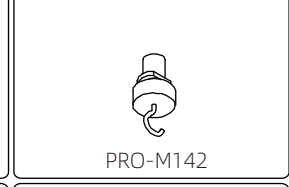
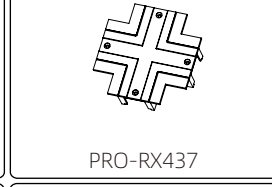
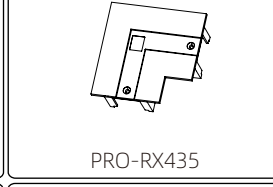
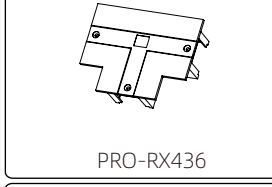
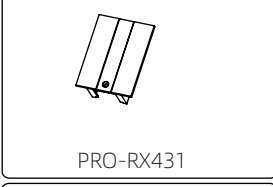
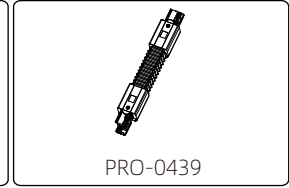
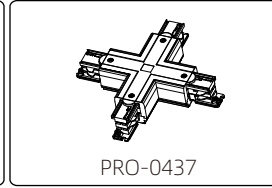
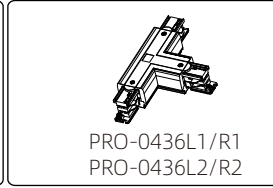
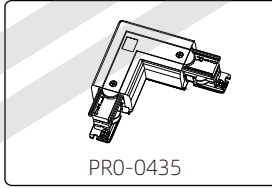
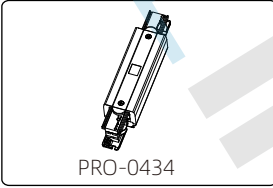
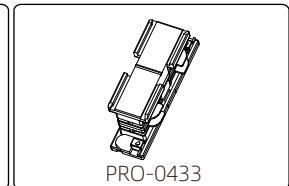
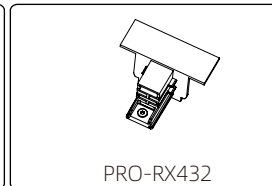
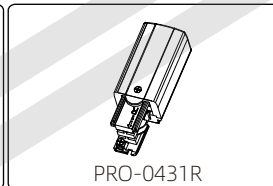
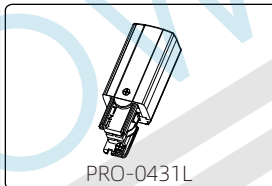
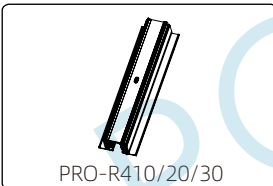
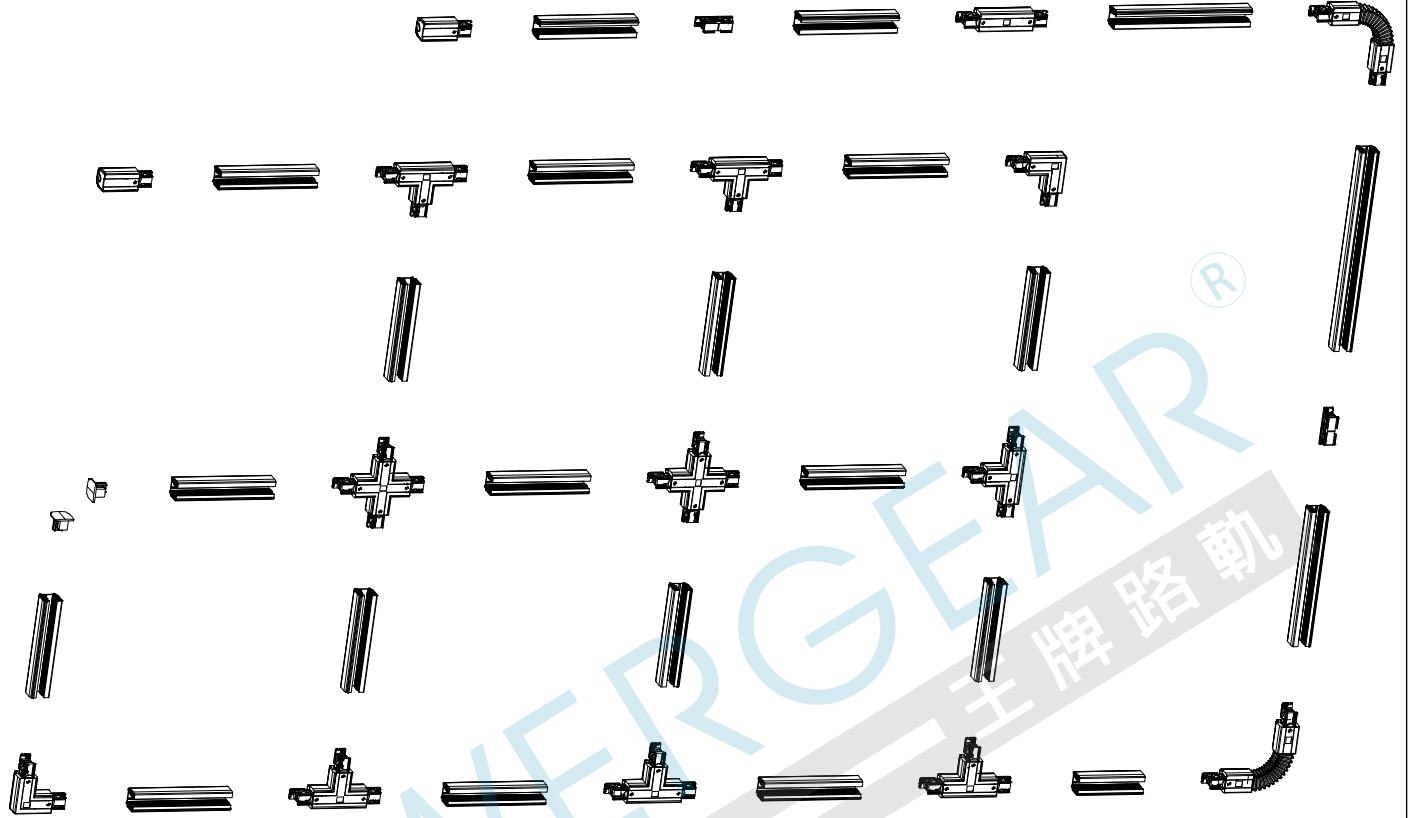

安裝示意 請在產品安裝前仔細閱讀本說明

L / mm	a / mm	b / mm	c / mm	d / mm	F Max./N
1000-1499	125				300N
1500-2499	125	995			450N
2500-3499	125		914	1172	600N
3500-4000	125		1247	1506	600N

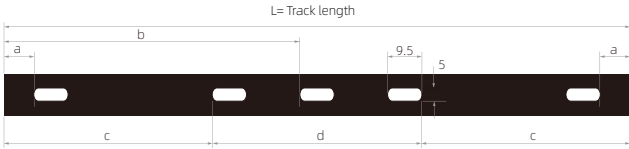

Track Length: 1-4m

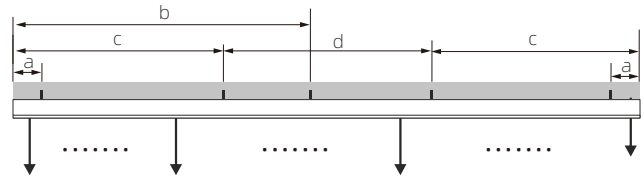

每個安裝點最大100N，每米最大有5個安裝點

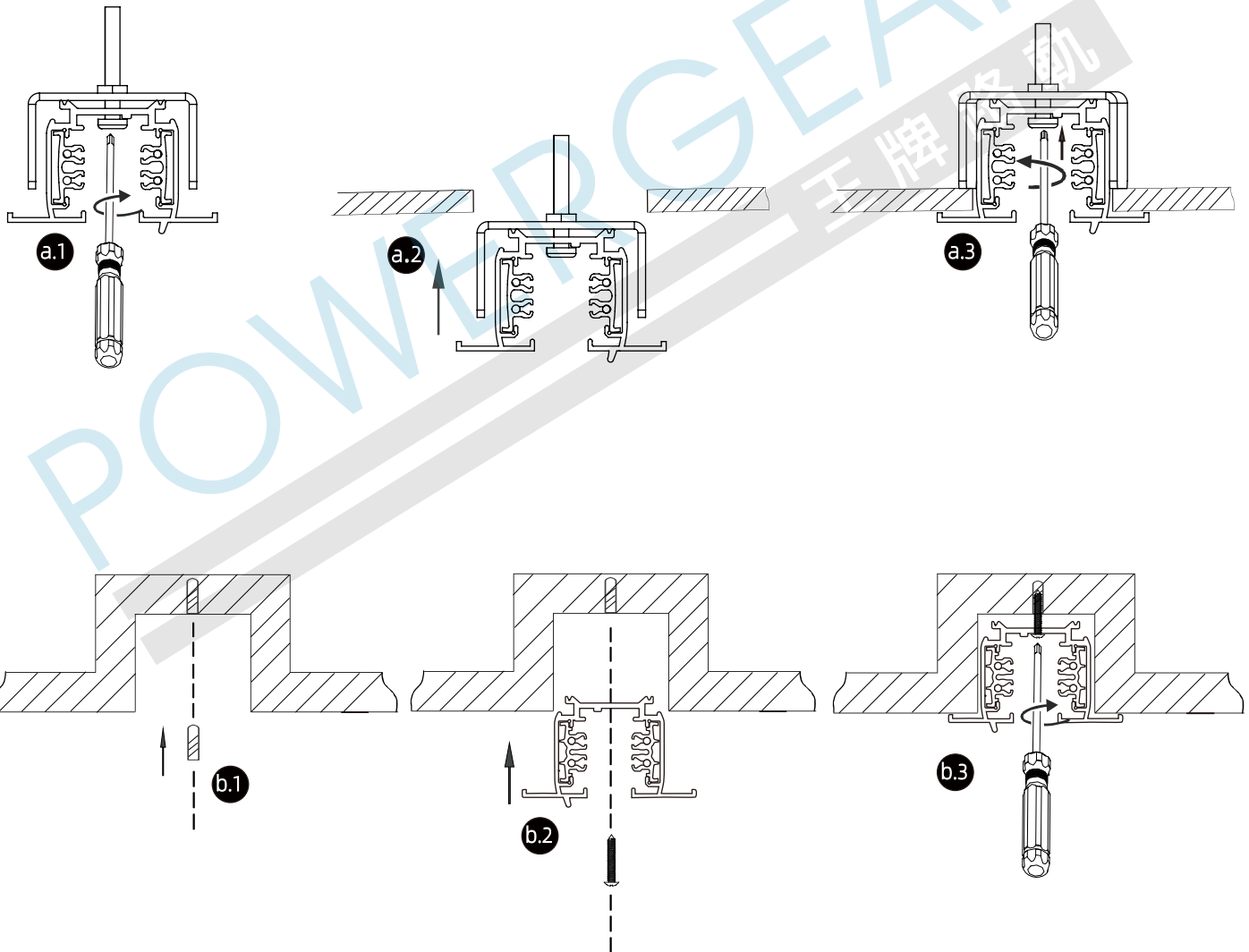
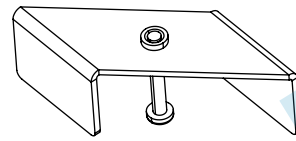
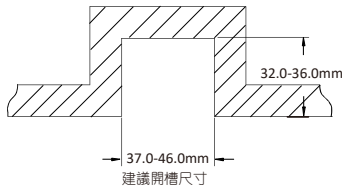

安裝示意 請在產品安裝前仔細閱讀本說明

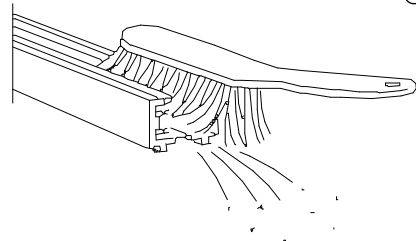
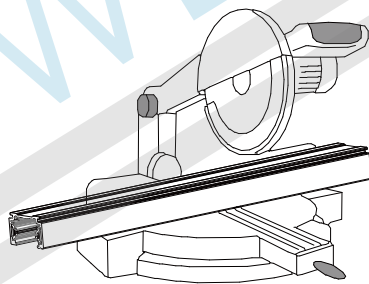
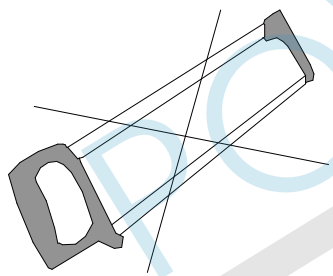
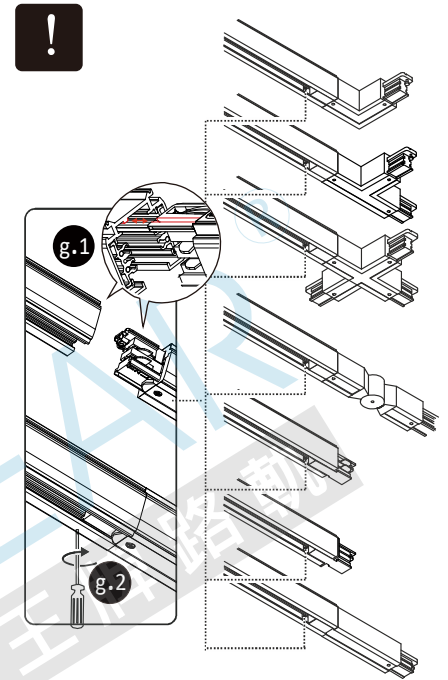
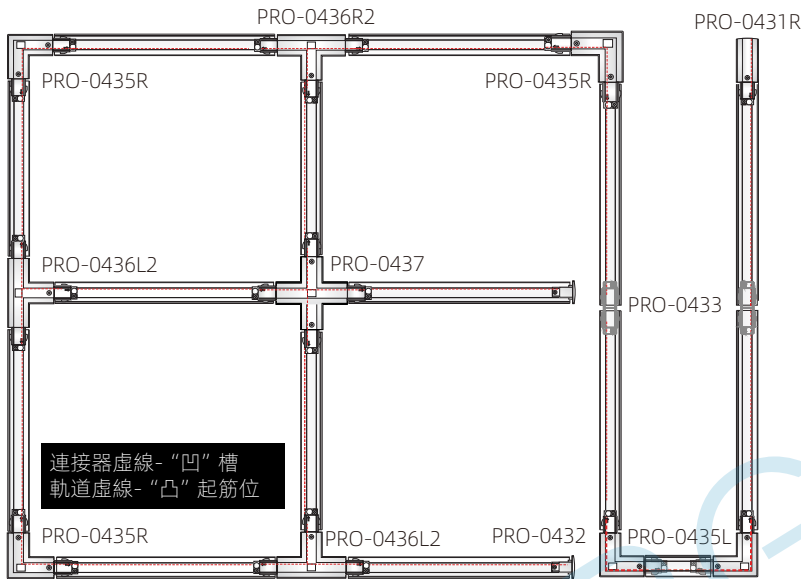

簡單故障排除

異常：路軌系統的迴路沒有電，或線電壓超過標稱值，請排查安裝是否存在以下異常：

- 1、請確保路軌系統內部的“凸”起筋位和各連接器“凹”槽方向一致；
- 2、請確保路軌系統之間內部的“凸”起筋位方向一致；
- 3、請確保連接器接線牢固，無鬆動及脫落情況，且與軌道安裝到位，防止虛接；
- 4、請確保電源進線盒按照標識接線。

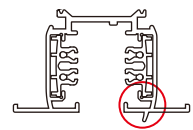

免責申明

- 1、禁止油漆，膠水等塗抹于本產品；
- 2、本產品適用於室內取電，不可用於戶外；
- 3、推薦使用原廠路軌系統，不承諾和其他軌道系統的兼容性；
- 4、未按操作說明使用/改裝本產品的結構或接線，造成本產品或關聯產品損壞的，產品無法繼續享有售後承諾；
- 5、產品的優化及版本升級恕不另行通知，請以收到的實物為準，如有任何疑問可及時聯繫我方銷售人員；
- 6、本資料最終解釋權歸POWERGEAR 王牌路軌所有。